

Recess mounted range of LED ceiling lights are a perfect fit for varied lighting applications. The luminaires have high quality LED source with low energy consumption and long service life. Designed for low / high mounting heights. The luminaires makes them especially suitable for installation in ceiling for both interior and exterior applications. Elegantly designed fixture under the green lighting, energy efficient category.

Product Description

- Luminaire made of die-cast aluminium has excellent mechanical strength, aluminium heat sink for better thermal management.
- Reflector with excellent optical effects.
- Cable entries for through-wiring of mains supply cable.
- Integral constant current power supply
- CRI (Ra) : ≥ 80 (90 CRI - On Request)
- Prewired with LED driver and suitable for operating on 240V, 50Hz single phase ac supply.
- Ordering guide : KL-4241-CCT (Colour Temperature)
- Available CCT : 3000K, 4000K, 6500K



Product Benefits

- High luminous efficiency at reduced wattage.
- Elegant, Robust design
- Quick & simple installation.
- Sustainable LED technology offers durability and optimal light output with low power consumption.

Area of Application

Retail Sector, Commercial & Business Centers, Residential town ships, Educational Institutes, Hospitality & Industrial sector, Entrance foyer.

Available Finish

White epoxy polyester powder coating.

Note

IP20 Dimmable driver. It should be in IP65 enclosure.





Technical Specifications

General

ID	: 4241
System Wattage	: 10W LED
Driver Integrated	: Constant Current
Input Voltage	: 230-240Vac
Frequency	: 50-60Hz
Operating Voltage	: 100-277Vac
Operating Temperature	: -15°C~+50°C

Physical

Body	: Die-Cast Aluminium
Reflector	: Aluminium
Diffuser	: Translucent PC
	Optical Cover
Mounting	: Recess
COD (mm)	: Ø90

Light Source

Light Source	: CITIZEN COB
LED Lumens	: 1500 lm
CRI (Ra)	: >80
LED Colour Temperature	: 3000K / 4000K / 6500K

Driver

Power Supply	: Integrated
Power Factor	: >0.9
THD	: <10%
Surge Protection	: 2.5KV
Efficiency	: >85%

Optical Performance

Colour Temperature	: 3000K / 4000K / 6500K
Luminous flux	: 689 / 716 / 909 lm
Beam Angle	: 45°

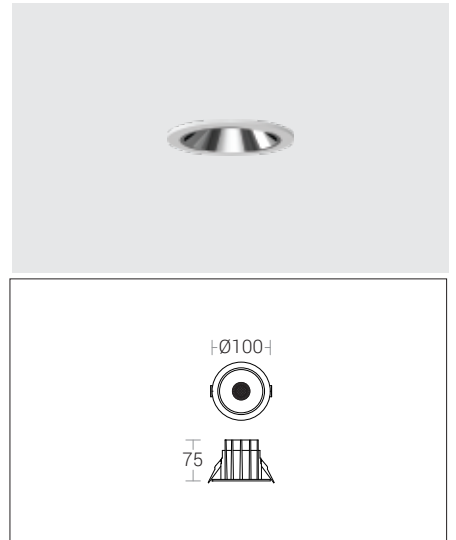

Photometric Data

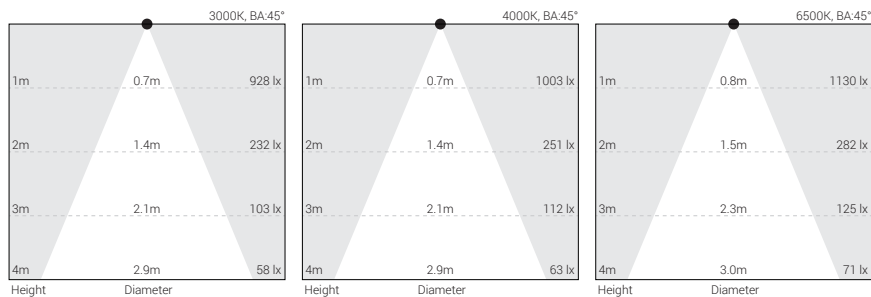



Technical Specifications

General

ID	: 4242
System Wattage	: 20W LED
Driver Integrated	: Constant Current
Input Voltage	: 230-240Vac
Frequency	: 50-60Hz
Operating Voltage	: 100-277Vac
Operating Temperature	: -15°C~+50°C

Physical

Body	: Die-Cast Aluminium
Reflector	: Aluminium
Diffuser	: Translucent PC
	Optical Cover
Mounting	: Recess
COD (mm)	: Ø130

Light Source

Light Source	: CITIZEN COB
LED Lumens	: 3000 lm
CRI (Ra)	: >80
LED Colour Temperature	: 3000K / 4000K / 6500K

Driver

Power Supply	: Integrated
Power Factor	: >0.90
THD	: <10%
Surge Protection	: 3KV
Efficiency	: >86%

Optical Performance

Colour Temperature	: 3000K / 4000K / 6500K
Luminous flux	: 1180 / 1470 / 1466 lm
Beam Angle	: 45°

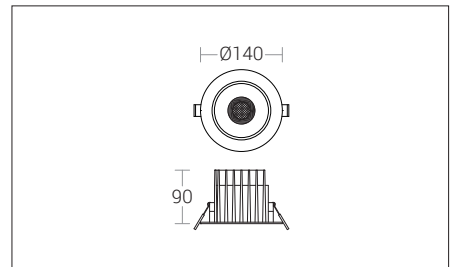

Photometric Data

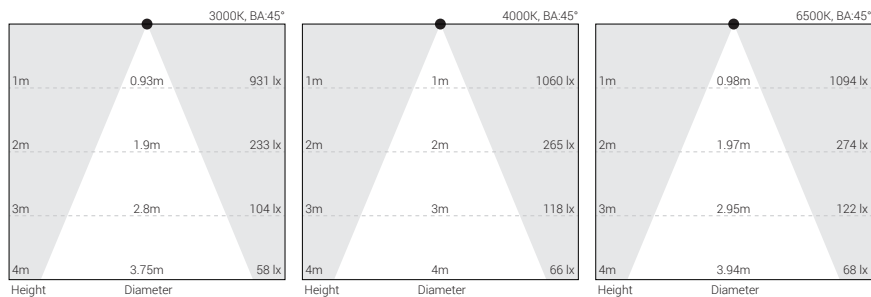



Technical Specifications

General

ID	: 4243
System Wattage	: 30W LED
Driver Integrated	: Constant Current
Input Voltage	: 230-240Vac
Frequency	: 50-60Hz
Operating Voltage	: 100-277Vac
Operating Temperature	: -15°C~+50°C

Physical

Body	: Die-Cast Aluminium
Reflector	: Aluminium
Diffuser	: Translucent PC Optical Cover
Mounting	: Recess
COD (mm)	: Ø155

Light Source

Light Source	: CITIZEN COB
LED Lumens	: 4500 lm
CRI (Ra)	: >80
LED Colour Temperature	: 3000K / 4000K / 6500K

Driver

Power Supply	: Integrated
Power Factor	: >0.90
THD	: <10%
Surge Protection	: 4KV
Efficiency	: >87%

Optical Performance

Colour Temperature	: 3000K / 4000K / 6500K
Luminous flux	: 1729 / 2004 / 1991 lm
Beam Angle	: 45°

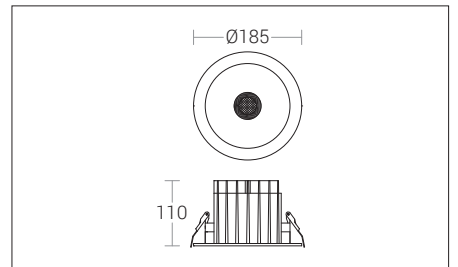

Photometric Data

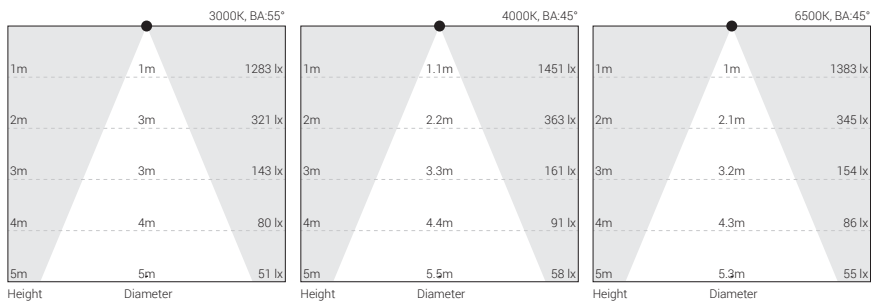



Technical Specifications

General

ID	: 4247
System Wattage	: 40W LED
Driver Integrated	: Constant Current
Input Voltage	: 230-240Vac
Frequency	: 50-60Hz
Operating Voltage	: 100-277Vac
Operating Temperature	: -15°C~+50°C

Physical

Body	: Die-Cast Aluminium
Reflector	: Aluminium
Diffuser	: Translucent PC
	Optical Cover
Mounting	: Recess
COD (mm)	: Ø200

Light Source

Light Source	: CITIZEN COB
LED Lumens	: 6000 lm
CRI (Ra)	: >80
LED Colour Temperature	: 3000K / 4000K / 6500K

Driver

Power Supply	: Integrated
Power Factor	: >0.90
THD	: <10%
Surge Protection	: 5KV
Efficiency	: >86%

Optical Performance

Colour Temperature	: 3000K / 4000K / 6500K
Luminous flux	: 2517 / 2275 / 2341 lm
Beam Angle	: 60°

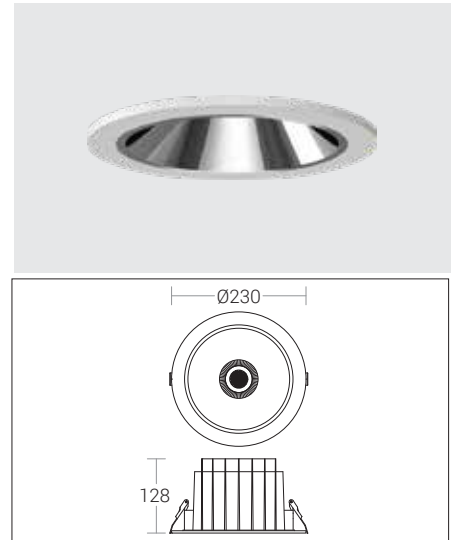

Photometric Data

